

# **DANVEX<sup>®</sup>**

Dehumidifiers for swimming pools

DEH-600wp / DEH-1000wp

DEH-1700wp / DEH-2000wp

>> Operation manual





Please read this instruction manual carefully and save it before using the dehumidifier.  
If you have any questions about using the dehumidifier, please contact your dealer.

## CONTENTS

INTRODUCTION .....	3
PRECAUTIONARY MEASURES .....	4
DESCRIPTION OF THE DEHUMIDIFIER .....	6
WIRING DIAGRAMS .....	7
INSTALLATION NOTE .....	8
START-UP AND OPERATION (DESCRIPTION OF THE CONTROL PANEL) .....	9
REMOTE CONTROL AND ERROR CODES .....	11
DEHUMIDIFIER MAINTENANCE .....	11
TECHNICAL SPECIFICATIONS .....	12
CAPACITY DIAGRAMS .....	13

---

## INTRODUCTION







### MODELS:

**DEH-600wp / DEH-1000wp / DEH-1700wp / DEH-2000wp**

All the dehumidifiers described in this manual are designed to maintain the relative humidity of indoor air in the range from 40% to 99%, at air temperature from +10°C to +35°C.

## PRECAUTIONARY MEASURES

- Read this manual carefully for safety before you start operating the dehumidifier. Below are the symbols used in this manual.

	Strictly forbidden
	Be sure to follow the instructions
	Provide grounding
	Unplug the power cord from network
	Never store anything on the device
	Electric shock hazard
	Never insert fingers or any items

**Do not disconnect / do not connect power supply during operation**

**If during operation there is something unusual (burning smell, etc.), turn off the device and disconnect it from the network**

- In case of incorrect operation of the device, contact Your dealer.

**Use grounding.**

- Avoid contact of the grounding wire with gas and water pipes, lightning rod or telephone cable. If the grounding is made incorrectly, it can lead to defeat electric shock hazard.



**CAUTION**

**There should be no breaks in the cord or its artificial extensions.**

**Remove any dirt from the plug of the power cord.**

- If dirt sticks to the plug of the power cord or plug and socket connection is loose, it may cause fire or electric shock.



**Do not scratch or bend the power cord.**

- Do not place heavy objects on the power cord, heat it, or expose to other factors. The cable may be damaged, which can lead to fire or electric shock.

**Consult Your dealer on installation of the device.**

**Do not insert fingers or any objects into the air intake/ outlet.**

**Do not attempt self-repair or re-installation of the device.**

- If this is done incorrectly, it may cause fire, electric shock, water leakage, etc.
- Contact Your dealer.

**PRECAUTIONARY MEASURES****CAUTION****Do not pull on the power cord.**

- It can cause a short circuit that may result in electric shock or fire.

**Do not use insect repellent or solvents.**

- This may cause fire or deformation.

**Before cleaning the device switch it off and disconnect the power cable from the mains.**

- As the fan rotates at high speed, cleaning of operating device can cause injury.

**Do not clean the device with water.**

- This can lead to electric shock.

**If the device is installed in a damp location, ensure its isolation from moisture.**

- If you do not provide isolation of the device from moisture, it may cause electric shock.

**If You are not going to use the device during a long period, unplug it from the mains.**

- If You do not, the device may accumulate dirt and cause a fire.

**Do not install the device where in unsafe operation conditions.**

- Do not install the device in a place where there is flammable gas.

**Unassisted installation of the device is forbidden.**

- If this is performed incorrectly, it may cause fire, electric shock, water leakage, etc.
- Please contact Your dealer or technician.

**Do not press the switches with wet hands.**

- This may cause electric shock.

## DEHUMIDIFIER DESCRIPTION

DEH-600wp / DEH-1000wp / DEH-1700wp / DEH-2000wp

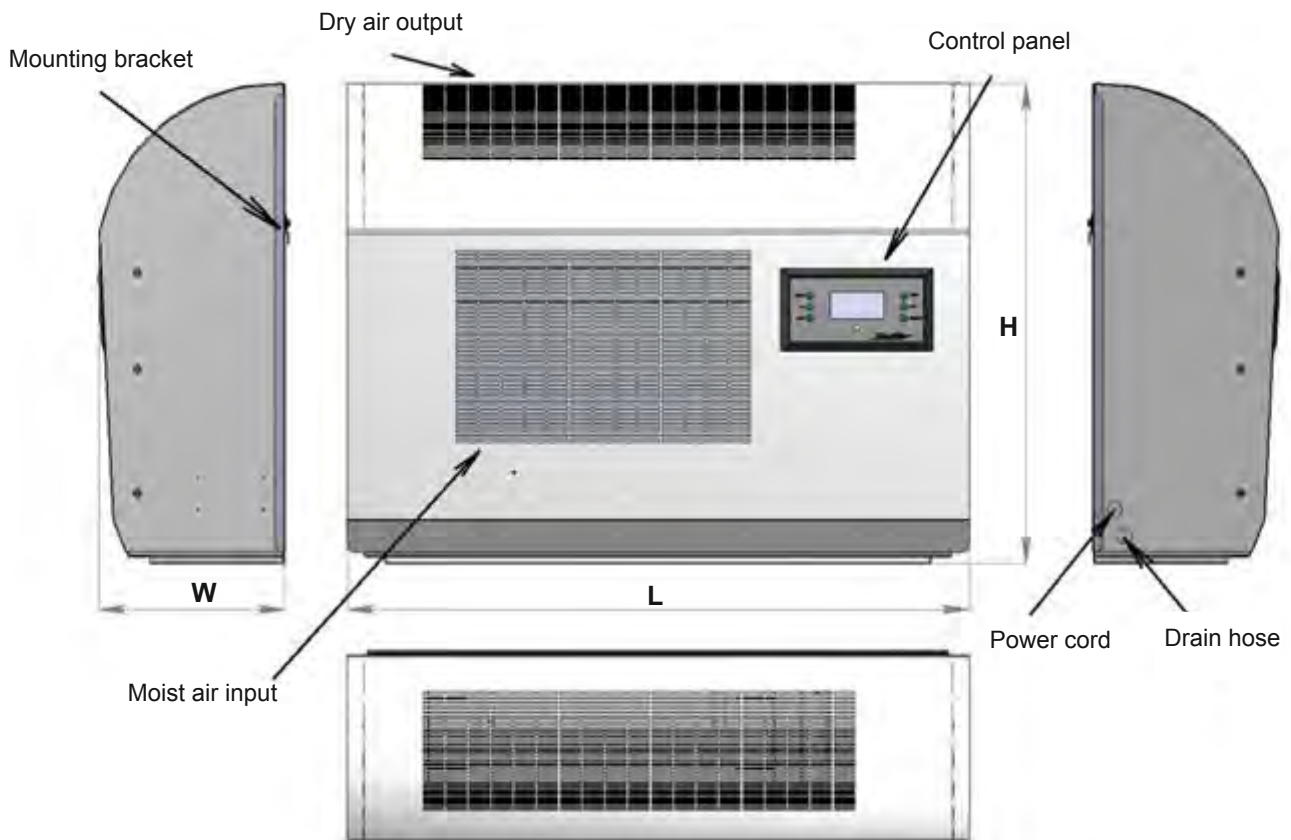

## WORKING PRINCIPLE DIAGRAM

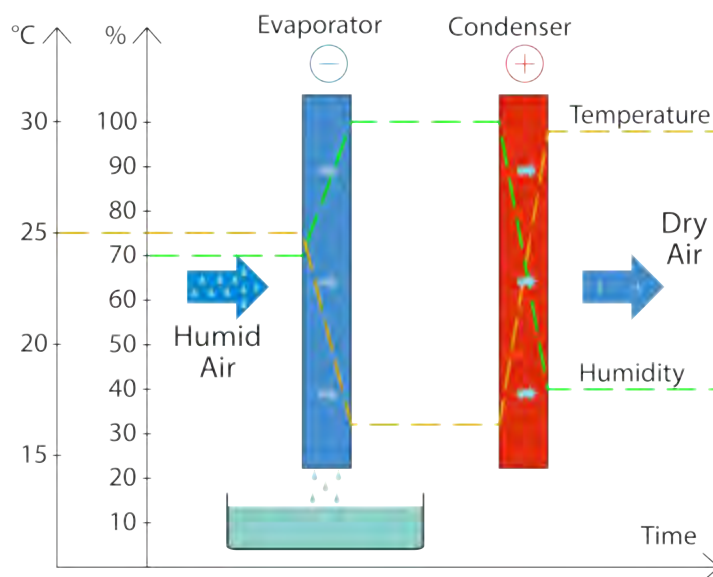

# WIRING DIAGRAM

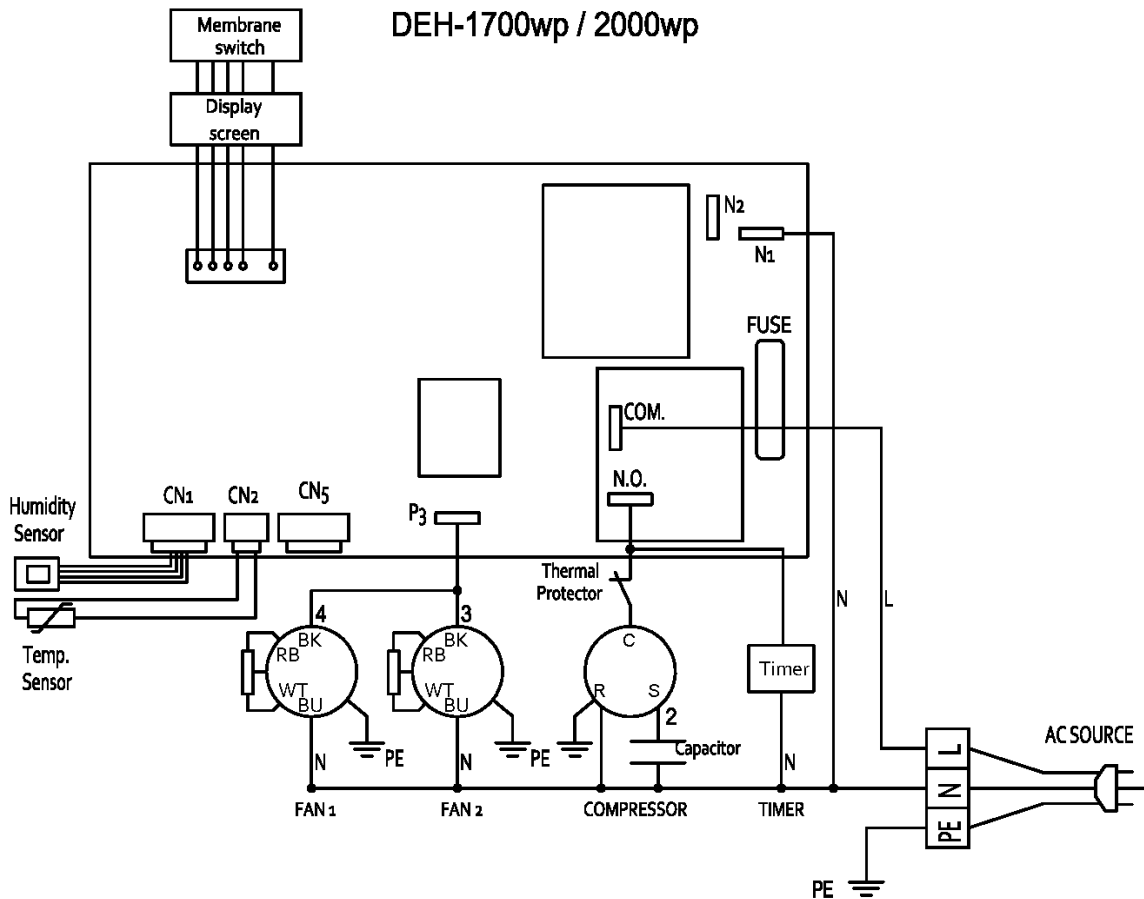
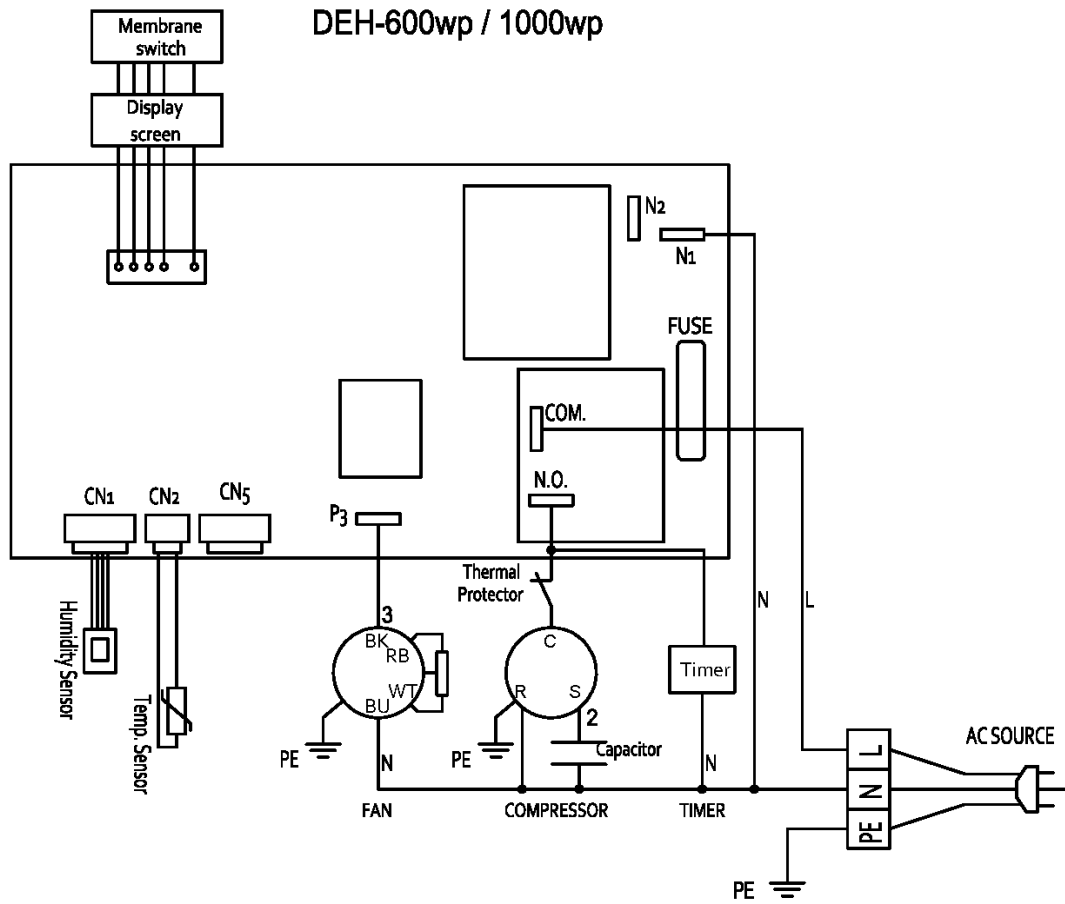



## INSTALLATION NOTE

### Before installation of the dehumidifier:

Before shipment from the factory all the dehumidifiers are subject to tests. Unpack the box and check for damage on the surface of the device, as well as for completeness of components in accordance with the list specified in the instructions. If You find any damage, do not attempt to install the humidifier and immediately contact the supplier.

**CAUTION!!!**

IF DURING TRANSPORT THE DRYER WAS LYING ON THE SIDE, IT NEEDS TO BE LEFT UPRIGHT FOR AT LEAST 24 HOURS BEFORE THE START OF ITS OPERATION!!!

(failure to perform this may cause damage to the dryer and void your warranty)

### Installation diagram

In case of indoor installation of the device, provide availability of free space for its maintenance. The premises, where the device is installed, must be ventilated.

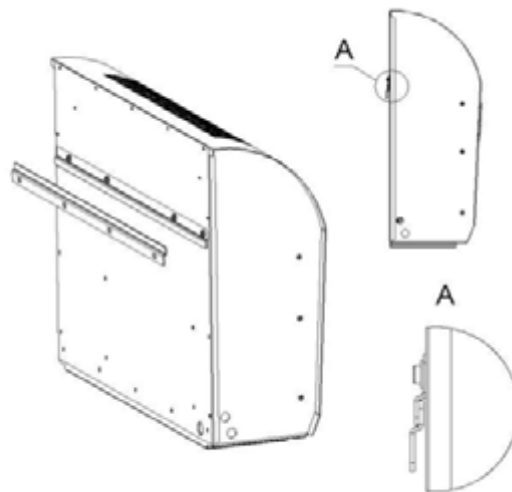

### Mounting of the dehumidifier on the wall:

Step 1: Select the correct position for mounting on the wall, depending on the size of the holes set and the holes positions of the wall mount bracket. The place of installation should guarantee the vertical position of the dehumidifier. Mark places for drilling.

Step 2: Use hammer drills to drill holes with depth of  $8 \pm 0.5$  cm Then use the anchor bolts and install them into the holes with a hammer.

Step 3: Install the wall bracket with anchor bolts in the correct position. Please, provide secure fixing of the bracket using nuts and washers. Don't forget to hold the bracket in the correct position during installation.

Step 4: Install the dryer on the wall bracket.

Step 5: Connect the drain hose to the dehumidifier. Turn on the dehumidifier for trial use. Check the device for presence of abnormal vibration and noise.

Step 6: Installation is finished and the dehumidifier is ready for use.

## Control panel



### Button Function

#### 1. "Power" / "ON/OFF" button

Press this button to start the machine, it enters start-up mode after the buzzer buzzes twice  
Press this button to stop the machine, it enters stop mode after the buzzer buzzes once

#### 2. "Timer" button

A, In standby mode, press "timer" to set Auto starting time, "on time" will flash in screen, and click "+" or "-" to adjust the time;

B, In working mode, press "timer" to set Auto stop time, "off time" will flash in screen, and click "+" or "-" to adjust the time;

#### 3. "+" button

Press this button directly to increase the set humidity. Buzzer buzzes once for each pressing and the set humidity decreases by 1% RH. Successive operation can be achieved by pressing this button successively. Press "Time" button before pressing this button, the time (hour) can be increased.

#### 4. "-" button

Press this button directly to decrease the set humidity. Buzzer buzzes once for each pressing and the set humidity decreases by 1%RH. Successively operation can be achieved by pressing this button successively. Press "Time" button before pressing this button, the time (minute) can be decreases.

## Operating the machine

1. Energize the power, the dehumidifier will beep for once

2. Press the "On/Off" button for once, the LCD display is light. After all displays are normal, the LCD displays current environment humidity;

3. Setting of humidity: press "+" and "-" buttons to set the required humidity.

When the set humidity is 3% less than current humidity, the dehumidifier works; when the set humidity is 3% more than current humidity, the dehumidifier stops.

4. When the set humidity is less than 30%, the dehumidifier enters the mode of successive dehumidification.

5. Setting of preset time

Press the "Time" button for the first time, the "hour" time on the display flashes, press "+" and "-" to adjust the current hour and minute time; Press the "Time" button for the second time, the "Start-up time" on the LCD flashes, press "+" and "-" to adjust the current hour and minute time; Press the "Time" button for the third time, the "Stop time" on the LCD flashes, Press "+" and "-" to adjust the current hour and time; Press the "Time" button for the fourth time, the mode of "preset time" can be canceled.

6. After setting the mode of preset time, if the dehumidifier is shut off, it will operate the whole mode of preset time; if it is in operation, it will operate the mode of "preset stop time".

## Operation Notice

1. When moving the machine, do not incline the machine for over 45° to avoid damaging the compressor.
2. Temperature for operation of this machine is 10 - °C.
3. When it is operating, the compressor gives off heat when it works, and ambient temperature may rise by 1-3°C. Such phenomenon is normal and is safe to use.
4. When ambient temperature is below °C and absolute humidity is relatively low, there is no need to use dehumidifier.
5. The air inlet and outlet must be away from the wall for at least 10 cm in order not to impair dehumidification effect.
6. Working environment shall be as airproof as possible to maximize dehumidification effect.
7. Dust on the air purification filter mesh may impair its effect or even cause failure. Please clean regularly for at least once a month. If there is much dust in the environment, it must be cleaned once a week or once a day. Pull down the front panel, clean the filter mesh. Tap the filter mesh slightly or eliminate the dust by vacuum cleaner or place the mesh in warm water (≤40°C and add appropriate neutral scour) and brush and then wash with clear water and dry it. Direct sunlight or baking shall be avoided to prevent deformation.

## Code of Failure (Error Codes)

This dehumidifier is able to automatically judge failure. If there is any failure, there will be failure code displayed on the humidity display window.

### List of errors:

- E1 - exchanger temperature sensor defective
- E3 - temperature sensor and air humidity is defective
- E4 (blinks) - refrigeration system malfunction: refrigerant leak or wrong operation of the compressor
- E5 - high temperature of the refrigerant in the system



***Please carefully review the control functions and make all necessary adjustments before using the dehumidifier.***

## REMOTE CONTROL

The scope of supply includes the infrared remote control. The remote buttons duplicate some of the functions of the control panel of the dehumidifier. To start using the remote you need to insert the battery R232 (supplied separately).

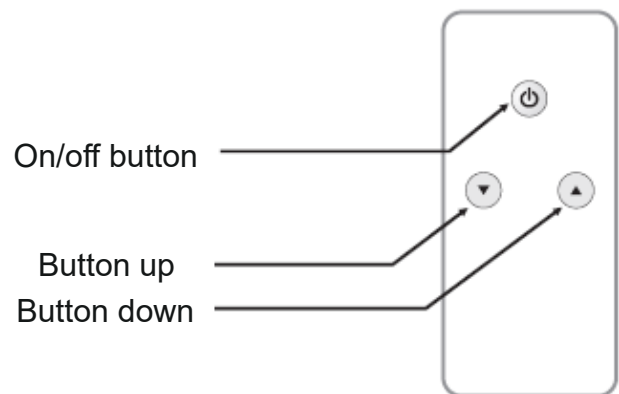

## DEHUMIDIFIER MAINTENANCE

### When You are not going to use the dehumidifier for a long time.

- 1** Start the process of air drying for 3-4 hours, setting the humidity levels at the level of 80% to dry the dehumidifier from inside.
- 2** Switch off the dehumidifier, then remove plug from outlet.

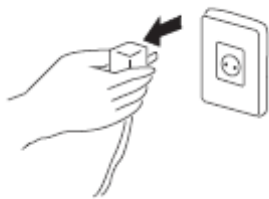

**⚠ CAUTION**  
Switch off the dehumidifier or remove the plug from the socket if you are not going to use it for a long time.

### When you are going to operate the dehumidifier again.

- 1** Make sure the air intake and outlet are not blocked.
- 2** Make sure the ground wire is connected properly

**⚠ CAUTION**  
**Use grounding.**  
Avoid contact of the grounding wire with gas and water pipes, lightning rod or telephone cable. If grounding was performed incorrectly, this may result in electric shock.

- 3** Remove the batteries from the remote control.

**TECHNICAL SPECIFICATIONS**

Model	DEH-600WP	DEH-100WP	DEH-1700WP	DEH-2000WP
Voltage	230V/1p/50Hz			
Capacity at 30°C/80% (l/24h)	60	100	170	200
Power (W)	650	980	1610	1950
Current (A)	3	4	6.8	8.0
Air flow (m <sup>3</sup> /h)	300	500	850	1100
Refrigerant	R410A			
Noise level (dB)	44	46	46	48
Net weight (kg)	45	50	70	85
Dimensions LxWxH (mm)	760x270x695	900x270x695	1410x270x695	

**NOTE:**

1. The nominal value of the noise level recorded in the laboratory.
2. In case of difference between the characteristics shown in the table above and the characteristics specified directly on the manufacturer label, you need to rely on the characteristics of the manufacturer's label.
3. Test data: air temperature 30°C, humidity 80%.

**SPECIAL INSTRUCTIONS:**

1. For expert installation and repair, contact the special Service department.
2. If a flexible cable is damaged, contact the special Service Department to replace it with the original cable.

## CAPACITY DIAGRAM

