

DanVex

DanVex DEH-3K
DanVex DEH-5K
DanVex DEH-10K
Industrial Condensing Dehumidifiers



DANVEX[®]

Manual of dehumidifier

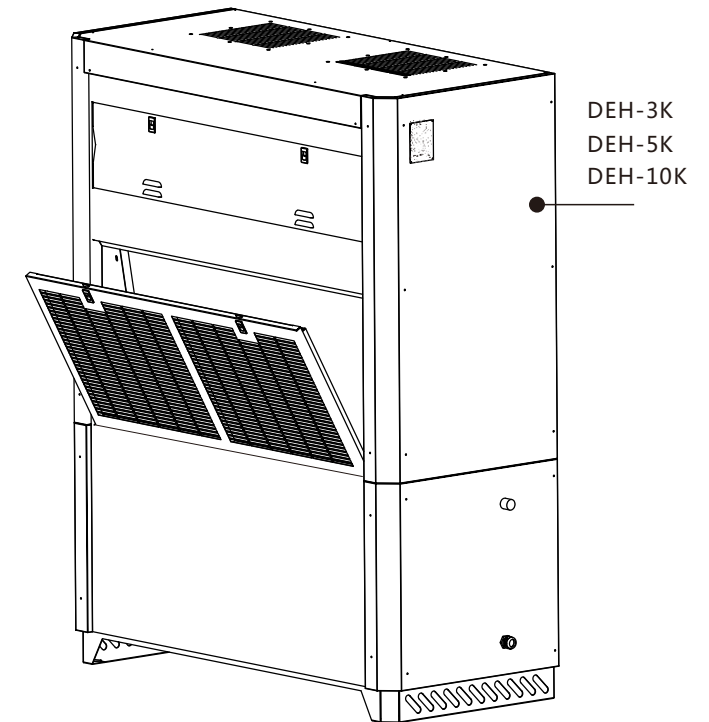

- Please read the manual carefully and in full before using the unit.
- Any questions, please contact the manufacturer or dealer in time.
- The repair and maintenance must be conducted by certified professionals.

Foreword

• Purpose of the Manual

Through the manual, you can understand the structure, installation specifications, control principles, process flow and operation methods of the cabinet-type dehumidifier.

• Knowledge Required

You need to have knowledge of automatic control and air handling to understand the manual.

• Contents Included

The manual explains in detail the functions, operation, daily maintenance and troubleshooting of the cabinet-type dehumidifier.

• All rights reserved

Copying of this manual, or part of it, is forbidden without prior written permission from DANVEX. The warranty and technical support of this product are only valid in the country or region of purchase.

NOTE

This unit must be operated by trained professionals, otherwise it will cause casualties or property damage.

Please read and understand this manual thoroughly before operation to avoid damage to the unit or personal injury or death caused by misoperation.

Please contact the supplier or the manufacturer if there are any issues arises that are not stated in this manual.

Please keep this manual for later reference.

Standards and Codes:

GB/4706.32-2004 China National Standard No. GB/4706.32-2004, Code of household and similar electrical appliances Particular requirements for heat Pumps, air-conditioner and dehumidifier

IEC 60335-2-40 International safety Standard for electric heat pumps, including sanitary hot water heat pumps, air-conditioners, and dehumidifiers incorporating sealed motor- compressors

GB/T16803-2018 China National Standard No. GB/T16803-2018, Code of of heating, ventilating, air conditioning and air cleaning terminology

GB/T17791-2007 China National Standard No. GB/T17791-2007, Code of of Specification for seamless copper tube for air conditioning and refrigeration field service

GB/755-2000 China National Standard No. GB/755-2000, Code of of Rotating electrical machines--Rating and performance

GB/T2518 China National Standard No. GB/T2518, Code of of continuously hot-dip zinc and zinc alloy coated steel sheet

GB/50016-2006 China National Standard No. GB/50016-2006, Code of Design on Building Fire Protection and Prevention

GB/50243-2002 China National Standard No. GB/50243-2002, Code of acceptance for construction quality of ventilation and air conditioning works

GB/50019-2003 China National Standard No. GB/50019-2003, Code for Design of Heating Ventilation and Air Conditioning

GB/50015-2019 China National Standard No. GB/50015-2019, Code for design of building water supply and drainage

GBJ16-87 China National Standard No. GBJ16-87, Code for fire protection of building design

GB/T7725-2004 China National Standard No. GB/T7725-2004, Code for room air conditioners

GB/T18883-2002 China National Standard for indoor Air Quality Standard

GB/T19411-2003 China National Standard for dehumidifiers

UL/474-1993 American Safety Standard for Dehumidifiers

GB/T191-2008 China National Standard for Packaging - Pictorial Markings for Handling of Goods

ANSI/AHAM DH-1-2008 ANSI/AHAM Standard for dehumidifiers

ANSI/UL94 American standard for Safety of Flammability of Plastic Materials for Parts in Devices and Appliances

























UL/484-2014 American standard for Room air conditioners

UL/969 American standard for marking and labeling systems used for permanent product identification

Warning

⚠ This symbol indicates the rules that must be followed! If it is not strictly followed, it may cause mild to moderate damage to the machine or signs of personal injury.

🚫 This symbol indicates actions that must be prohibited!! If not strictly followed, it may cause serious damage to the machine or personal injury or death.

| | | | | | |
|---|--|---|--|---|---|
|  | Please follow this manual for installation. Please read this manual carefully before running or servicing the unit. |  | The installation should be carried out by the seller or qualified professionals, please do not install the unit by yourself. Incorrect installation may cause accidents such as water leakage, electric shock or fire. |  | For units using line control, the line controller store must be connected first, otherwise the line controller will be unusable. |
|  | Before installation, please check whether the power cord used is consistent with the power required on the nameplate, and check the safety of the power supply. |  | The unit should be grounded, and the power socket must be equipped with a ground wire to ensure that the machine is effectively grounded through the power socket to avoid the risk of electric shock. Do not connect the ground wire to gas pipes, water pipes, lightning rods or telephone wiring. |  | Do not use or store flammable and explosive dangerous goods next to the unit. There should be at least 1.5m between the combustible surface and the unit. |
|  | SPECIAL ACCESSORIES Be sure to use special accessories and parts during installation. Otherwise, it may cause water leakage, electric shock, fire and other accidents. |  | The space above the equipment installation is at least 50 cm, the rear and the left and right sides are at least 100 cm, and the front is at least 200 cm. |  | After installation, please check and confirm whether the connections of drain pipes, ducts and wires are correct to prevent water leakage, refrigerant leakage, electric shock or fire accidents. |
|  | SPECIAL The power connection of this unit adopts Y-type connection, and the diameter of the power cord should be large enough. If the power cord is damaged, in order to avoid danger, the power cord should be replaced by the manufacturer or professionals. |  | Drainage pipes should be installed correctly in accordance with the installation instructions to ensure proper drainage, and insulation measures should be taken to avoid condensation. Improper installation of pipes will cause water leakage. |  | Do not step on the unit, and do not place objects on or on the air inlet and outlet of the unit. |
|  | Do not insert your fingers or objects into the air outlet or return air grille. |  | Volatile liquids such as thinner or gasoline will damage the appearance of the unit. (Only use a soft dry cloth and a damp cloth dampened with a neutral detergent to clean the casing of the unit). |  | Do not repair the unit by yourself. Wrong maintenance will cause electric shock or fire. |
|  | Do not start or stop the unit by pulling out the plug. |  | Once the unit is turned on, it must run for at least 5 minutes before it can be turned off, otherwise it will affect the compressor oil return. |  | After the unit is installed, electric leakage test should be carried out. |
|  | Do not allow children to operate the unit. |  | Do not operate the unit with wet hands. |  | When the unit is not used for a long time, please cut off the power supply of the unit. |
|  | The unit can only be cleaned after shutting down and cutting off the power supply, otherwise you may get an electric shock or be injured. |  | Do not pour or rinse the unit with water, otherwise it may cause malfunction or risk of electric shock. |  | When a problem occurs (such as a burning smell, etc.), please turn off the unit and unplug the power cord. (Cut off the power supply). |

DANVEX assumes no responsibility for personal injury or equipment damage caused by improper installation, commissioning, unnecessary maintenance, and failure to follow the regulations and instructions in this manual.

TABLE OF CONTENTS

| | |
|--|----|
| 1. General | 1 |
| 1.1 Application | 1 |
| 1.2 Content | 1 |
| 2. Unit | 2 |
| 2.1 Introduction | 2 |
| 2.2 Working Principle | 2 |
| 2.3 Performance Curve | 3 |
| 2.4 Airflow Direction | 4 |
| 2.5 Housing & Structure | 4 |
| (2.5.1) Unit Housing | 4 |
| (2.5.2) Air Inlet & Outlet | 4 |
| (2.5.3) Dehumidification Section | 5 |
| (2.5.4) Compressor | 5 |
| (2.5.5) Throttling Section | 5 |
| (2.5.6) Controller Protection | 5 |
| (2.5.7) Structure & Dimension | 6 |
| 2.6 Technical Parameters | 8 |
| 3. Installation | 9 |
| 3.1 Introduction | 9 |
| 3.2 Delivery & Storage | 9 |
| 3.3 Inspection | 9 |
| 3.4 Unit Movement | 9 |
| 3.5 Location Requirement | 9 |
| 3.6 Ground Level | 9 |
| 3.7 Duct Connection | 10 |
| 3.8 Negative-pressure Drainage Pipe Installation | 10 |
| (3.8.1) Drainage Pipe Test | 11 |
| 3.9 Wiring | 12 |
| 3.10 External Humidity Sensor Connection | 12 |
| 4. Ducting | 13 |
| 4.1 Introduction | 13 |
| (4.1.1) Non-ducted Installation | 13 |
| (4.1.2) Ducting for Fresh Air | 13 |
| (4.1.3) Installation with HVAC system | 14 |
| 5. Commitioning | 15 |
| 5.1 Introduction | 15 |
| 5.2 Unit Check | 15 |
| (5.2.1) Duct Check | 15 |
| (5.2.2) Wiring Check | 15 |
| (5.2.3) Controller Check | 16 |
| 5.3 Unit Running | 16 |
| 5.4 Air rate Adjustment | 16 |
| 5.5 Performance Test | 16 |
| 6. Controller | 17 |
| 6.1 General | 17 |
| (6.1.1) Controller Terminals | 17 |
| (6.1.2) Terminals Diagram | 17 |
| (6.1.3) Controller' s Interface | 18 |
| (6.1.4) Parameters Setting | 19 |
| (6.1.5) Icon | 20 |
| 6.2 Controller Logic | 21 |
| (6.2.1) Working Mode | 21 |
| (6.2.2) Dehumidification Working Mode | 21 |
| 6.3 Initial Value | 21 |
| 6.4 Fan Control | 22 |
| 6.5 Air Damper Control | 22 |
| 6.6 Defrost Control | 23 |
| 6.7 Alarm | 23 |
| (6.7.1) Filter Alarm | 23 |
| (6.7.2) Built-in temp.&humid sensor Error | 23 |
| (6.7.3) RS485-1 Communication Error | 23 |
| 6.8 Working Status Display | 24 |
| 6.9 Error Code | 24 |
| 6.10 External temp.&humid sensor | 24 |
| 6.11 Parameters Set | 25 |
| 6.12 RS4885-2 Mod-bus Communication Protocol | 26 |
| 6.13 Wi-Fi Connection | 27 |
| 7. Maintenance | 29 |
| 7.1 Introduction | 29 |
| 7.2 Filter | 29 |
| 7.3 Motor | 29 |
| 7.4 Technical Description | 29 |
| 8. Troubleshooting | 30 |
| 8.1 Introduction | 30 |
| 8.2 Description | 30 |
| 9. Electric Diagram | 31 |

1. General

1.1 Application

Cabinet-type dehumidification equipment adopts direct evaporative cooling design, which can dry the air under atmospheric pressure. The dehumidification equipment can dehumidify the air with a temperature range of 5°C to +35°C within 100% relative humidity. It is widely used in hotels, office buildings, hospitals, commercial and residential, scientific research institutions and other places.

The cabinet-type dehumidifier can work normally in the following temperature range. It will not work normally outside this range, which is not a quality problem of the equipment itself.

| Temp | | Indoor | Outdoor |
|------------|-----|---------|---------|
| | | DBT(°C) | DBT(°C) |
| Dehumidify | Max | 35 | 35 |
| | Min | 5 | 2 |
| Ventilate | Max | 40 | 45 |

1.2 Content

This manual is for the users of dehumidifiers, including installation, operation, maintenance, and troubleshooting.

This manual introduces cabinet-type dehumidification equipment. The dehumidification air volume of the system is 3 500m³/h--10 000m³/h, and the dehumidification capacity of the system is 300 L/day---1000 L/day

This equipment has a wide range of applications, such as:

- Business hotels.
- Villas
- Scientific research institutions.
- Museums and laboratories
- Product drying
- Other wet areas

2. Unit

2.1 Introduction

The design of the dehumidifier meets the requirements of the IEC protection level IP 45.

2.2 Working Principle

(Figure 1)

The internal circulation of the dehumidifier: through the operation of the compressor → discharge high temperature and high pressure gas from the exhaust port → enter the condenser for cooling → It becomes a low-temperature and high-pressure gas → intercepted by a capillary tube → becomes a low-temperature and low-pressure liquid → vaporizes and absorbs heat through an evaporator → back The compressor becomes a low-temperature and low-pressure gas.

(Figure 2)

External circulation of dehumidifier: It uses a refrigerator to dehumidify with a ventilation system. Compared with other dehumidification methods (heating dehumidification, ventilating dehumidification, adsorption dehumidification), it is characterized by stable, reliable, and continuous performance. The working principle is the fan draws warm & humid air through the refrigerated evaporator (cooling coil). The air is cooled well below its dew point: temperature decreases and moisture removed. The water condenses on the cold surface of the evaporator and drips into a water container (and then flows by gravity into drain pipe) or is led directly to a drain. Then, the cold dry air continues through a hot condenser which heats it up and returns it to the room to pick up new humidity. This procedure is continued until the desired condition is achieved.

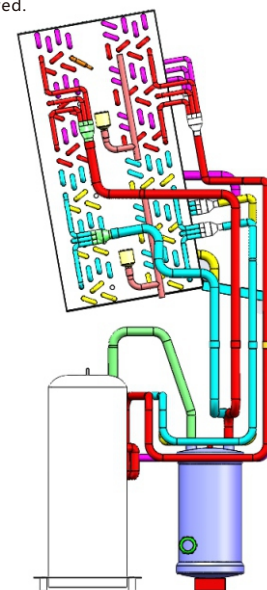

Figure 1

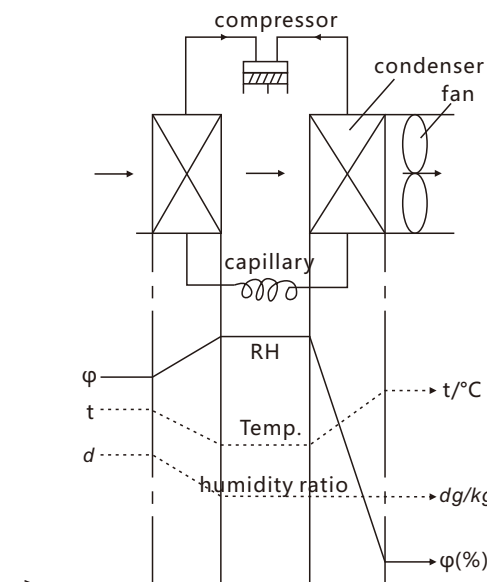
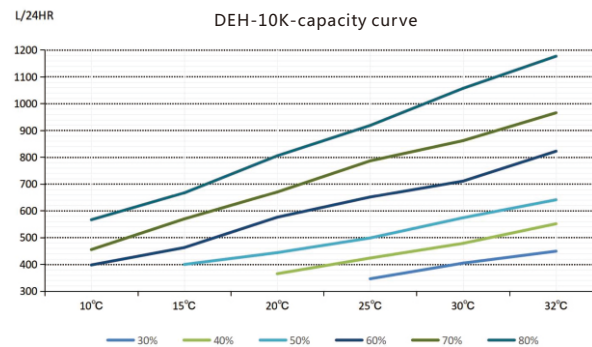
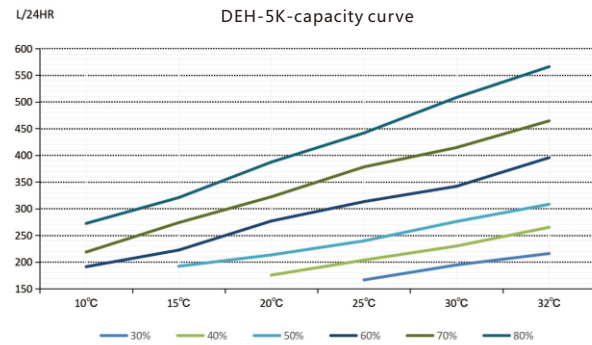
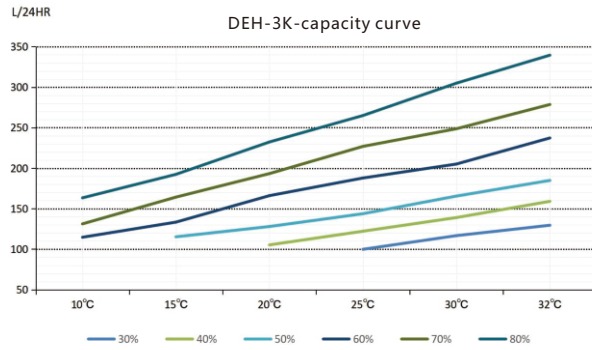
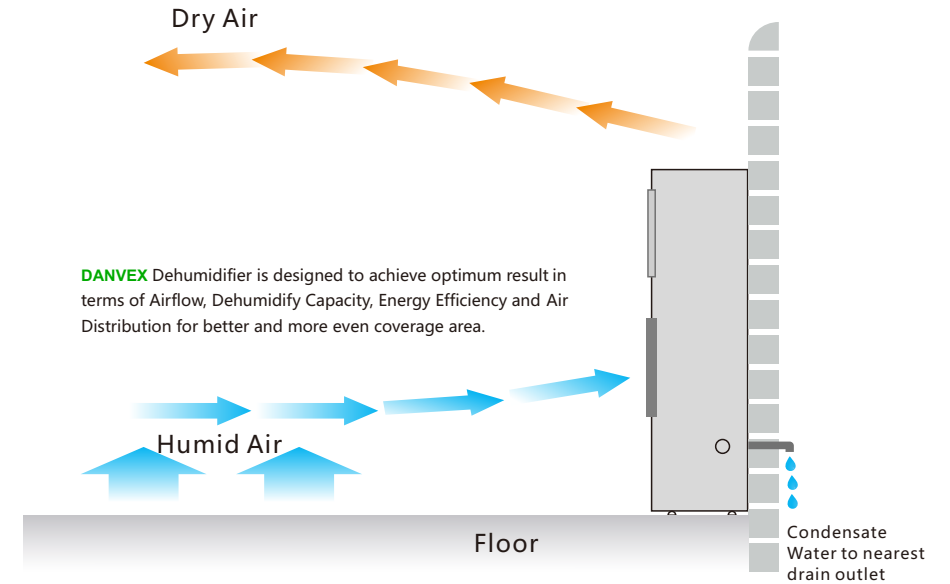

Figure 2

2.3 Performance Curve



2.4 Airflow Direction



2.5 Housing & Structure

2.5.1 Unit Housing :

- The cabinet-type dehumidifier adopts a steel frame structure. It has a compact structure, strong corrosion resistance, and is equipped with an anti-cold bridge device, which effectively prevents the occurrence of "condensation".
- It has seamless detachable panels. The maintenance of the equipment can be easily carried out.
- The unique defrosting device effectively guarantees the reliable operation of the dehumidifier.
- The selection and design of various functional components take into account the minimum pressure drop, so that the operation is reliable and economical.
- The unique stainless steel drain pan design ensures that all condensed water is discharged and prevents moisture accumulation.

2.5.2 Air Inlet & Outlet :

- The air inlet is equipped with a filter, with a filtration efficiency of 35% (weight method), and the filter is easily to be disassembled.
- The fan adopts a centrifugal external rotor fan, steel volute and blades, with high efficiency and low noise.

2.5.3 Dehumidification Section :

- The system design has added an energy-saving heat exchanger, which adopts a combined design of a liquid separator and a heat exchanger, which can effectively adjust the liquid flow function of the system, and can also maximum the dehumidification capacity to ensure the optimal operation of the compressor. The system adds a dry filter to effectively prevent the turbid impurities in the system from blocking the expansion valve or capillary tube.
- The defrosting adopts a patented structure device to ensure the stable operation of the refrigeration system. The unique defrosting is gradually adopted without affecting the operation of the system.
- The heat exchanger adopts hydrophilic membrane fins, the heat exchange efficiency is increased by 20%, thus to reduce the unit size and weight. The high-quality thermal insulation material increases the thermal insulation effect by 15%.

2.5.4 Compressor :

The compressor is the core part of the dehumidifier. Its performance characteristics directly affect the performance and characteristics of the cabinet dehumidifier. The compressor is the core of the entire dehumidification system and the source of system power. The power of the entire dehumidification is all provided by the compressor. The compressor is equivalent to moving a physical object from a low potential position to a high potential position. In the dehumidifier, its purpose is to compress the low-temperature gas into high temperature through the compressor. Finally, the gas exchanges heat with other media in the heat exchanger. The compressors are all imported brands.

2.5.5 Throttling Section :

The throttling component is one of the four indispensable components of the refrigeration system. Its function is to throttle and reduce the pressure of the high-pressure liquid from the condenser, so that the liquid refrigerant vaporizes and absorbs heat at low pressure (low temperature). Therefore, it is an important part to maintain the high pressure in the condenser and the low pressure in the evaporator. Due to the direct expansion method, the cooling loss is small and the efficiency is high. At the same time, it also has the function of preventing liquid shock to protect the compressor and abnormal overheating. The expansion valve has a stable degree of superheat, which makes the system run stably.

2.5.6 Controller Protection :

- The self-developed dehumidifier controller has more powerful functions, and the overall operating performance of the unit is higher, ensuring uninterrupted operation of the equipment.
- Motor overload and short circuit protection: The supply fan motor and the compressor motor have overload and short circuit protection functions.
- Power-on protection: When the dehumidifier is turned off under normal circumstances, it will take 3 minutes to restart the protection when it is turned on again.
- Shutdown protection: When the dehumidifier is turned off under normal circumstances, the fan will keep working for 3 minutes to ensure the heat radiated.
- Fan working mode: After the humidity is reached, you can choose whether the fan is running or not.
- High-temperature protection: The unit is designed with high-temperature protection to prevent the compressor from burning under continuous operation at high temperature.
- Low-pressure protection: Prevent the compressor from burning out due to continuous operation without refrigerant in the system.

2.5.7 Structure & Dimension

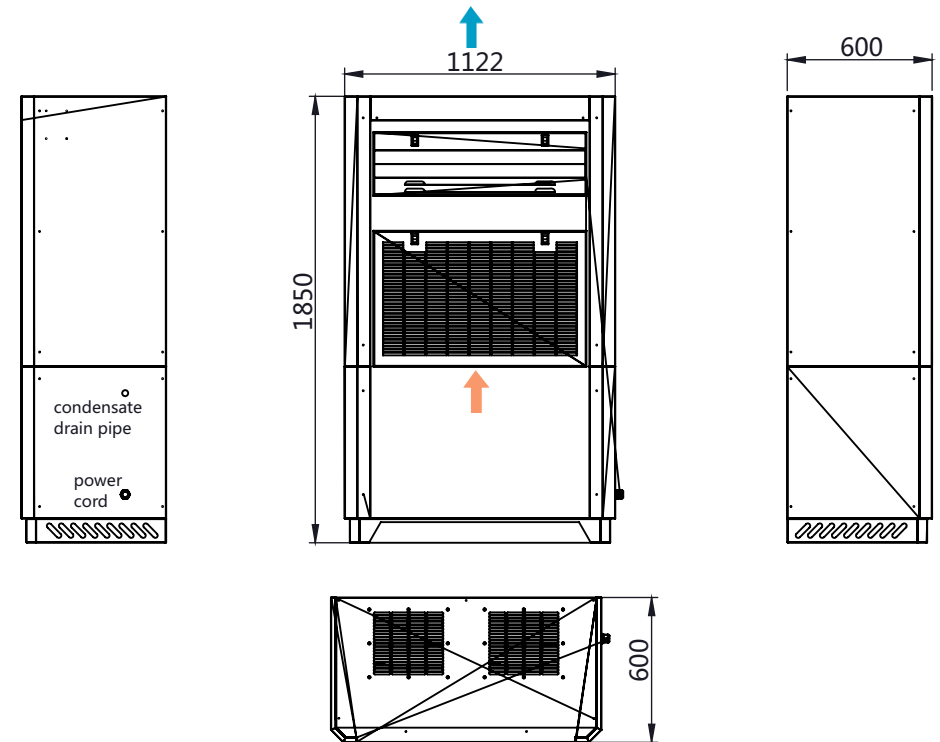
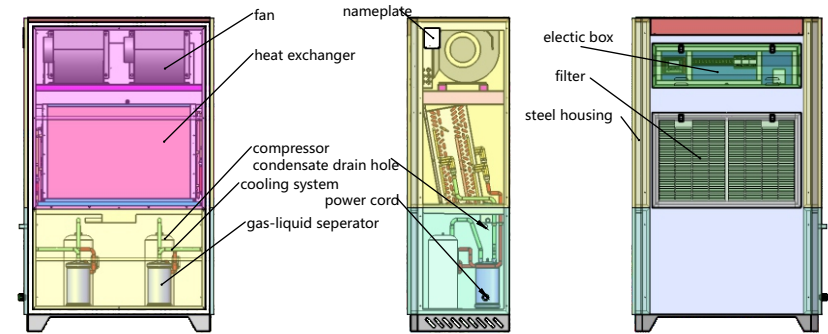

DEH-3K/5K

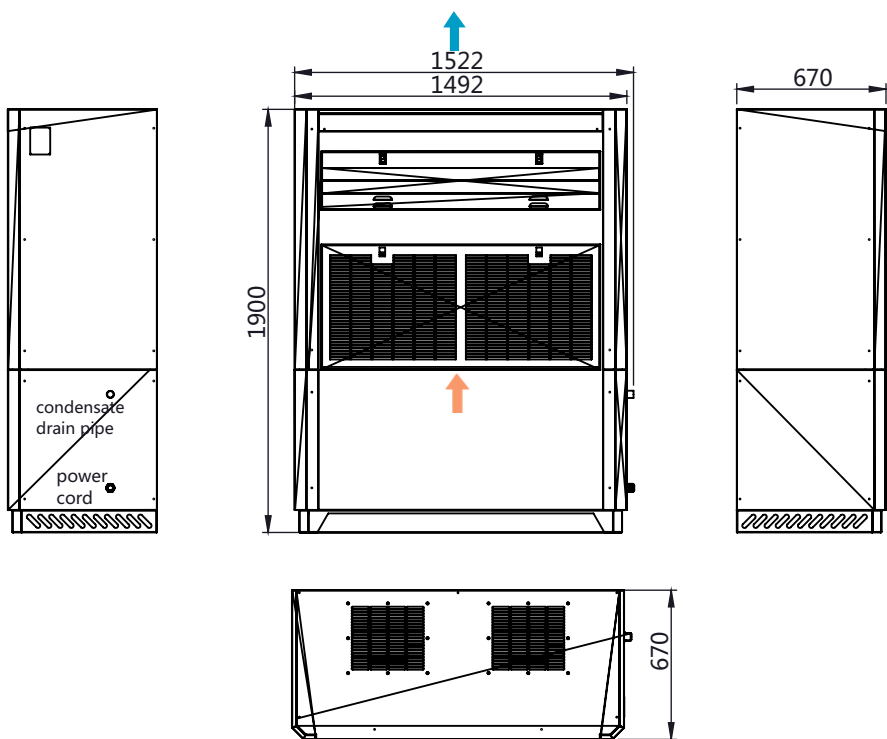
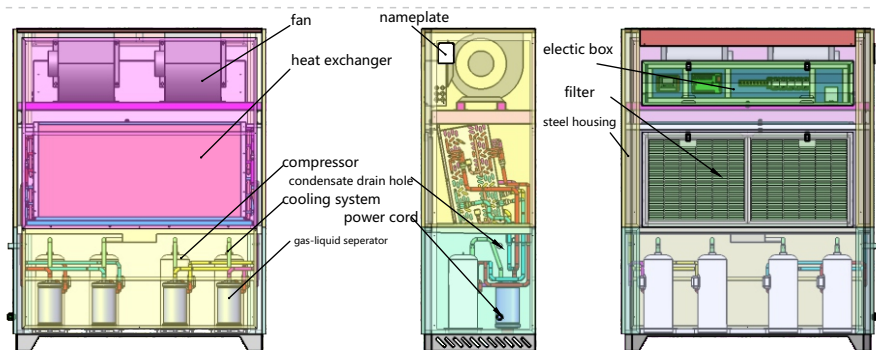

DEH-10K

2.6 Technical Parameters

| Model | DEH-3K | DEH-5K | DEH-10K |
|-------------------|---|-----------------------|-------------------------|
| Test conditions | 30°C 80% | 30°C 80% | 30°C 80% |
| Capacity | 300L/D | 500L/D | 1000L/D |
| Fan type | Centrifugal | Centrifugal | Centrifugal |
| Pressure | 200 PA | 200 PA | 300 PA |
| Supply air | 3500m ³ /h | 5000m ³ /h | 10 000m ³ /h |
| Return air | 3500m ³ /h | 5000m ³ /h | 10 000m ³ /h |
| Power | 6KW | 11KW | 22KW |
| Current | 10.8A | 20A | 40A |
| Voltage/Frequency | 380V/50HZ | | |
| Controller | Built-in humidity & temp. sensor | | |
| IP rating | I/IPX3 | | |
| Noise | < 55DB | < 60DB | < 65DB |
| Compressor | Mitsubishi/R410A | | |
| Coil type | copper tubes with blue hydrophilic-coated aluminum fins | | |
| Drain pan | SUS304 | | |
| Drain hole size | Φ25 | Φ32 | Φ32 |
| Filter | G4 PRE Filter | | |
| Dimension | 1122*600*1850mm | 1122*600*1850mm | 1492*670*1900mm |

3. Installation

3.1 Introduction

The cabinet type dehumidifier can be installed in many places, depending on the needs of the owner. If required, it can also be used in combination with the existing power system or the existing air duct system. This chapter covers the instructions required for installation, read before the equipment is installed, will help you to arrange the work correctly.

3.2 Delivery & Storage

In order to ensure the quality and reliability of the dehumidifier, each unit has been inspected before leaving the factory. If the unit needs to be stored for a period of time before installation, the following items should be noted:

- It is not advisable to remove the shipping packaging.
- The location of the equipment should be avoided physical damage.
- It should be stored under a cover to prevent the intrusion of dust, frost and rain.

3.3 Inspection

Disassemble the shipping packaging of the unit and inspect it to ensure that it is not damaged during transportation.

- If you find any damage, please contact the manufacturer.
- If the duct connected to the unit has been arranged, check whether the duct is appropriate.
- If the environment and installation conditions are not satisfactory, please contact the relevant design and technical personnel of the manufacturer.

3.4 Unit Movement

The unit is heavy and can be moved on flat ground. If the distance is long, it can be lifted and transported on the base of the unit with a hydraulic truck. In order to prevent damage to the unit and personal injury, it is recommended to use lifting equipment. Cabinet-type dehumidifier must be treated with care. When the unit is moving, a crane or forklift can be used. When using a crane, a suitable lifting point should be selected. The lifting point cannot touch the motor, control system and exposed pipe fittings to avoid damage to the unit.

3.5 Location Requirement

In order to obtain the best operating status and fault maintenance services, cabinet-type dehumidification equipment should be installed indoors. During installation, there should be maintenance space at the rear of the dehumidification equipment to facilitate future inspection and maintenance of the equipment. For cleaning and maintenance purposes, it is very important to keep the necessary and compact service space. In order to prevent condensation inside the dehumidification equipment, the unit should not be exposed to an environment with a temperature lower than the dew point of the processing air.

**The equipment should be placed close to the socket equipment and easily connected.
(Note: When installing the equipment, consider retaining enough space for maintenance.)**

3.6 Ground Level

Cabinet-type dehumidification equipment must be installed horizontally. Please use a level to measure the flatness of the equipment to prevent residual condensate, which will cause the dehumidifier to leak water and damage the entire environment.

3.7 Duct Connection

If the air outlet is connected to a duct, the size of the treated air duct should comply with the recommended value of ISO7807. For the installation of pipe joints of ducts and elbow flanges, the bolt length shall not exceed 20mm. For an ideal installation, the air is drawn from the central area of the room, dehumidified, and then transported to each individual room, such as a bedroom and an office. Install the return air outlet of the dehumidification unit and

When connecting the outlet to the pipeline, the following recommendations should be noted:

- Minimize the length of the air duct in order to reduce the static pressure loss of the air system.
- In order to ensure performance, all rigid (galvanized) pipe connections must be airtight.
- The duct should be insulated to avoid condensation on the outer wall of the duct when the temperature of the airflow in the duct drops below the dew point temperature of the outside air, which may lead to duct corrosion; and energy loss can be avoided.
- The pipeline directly installed on the dehumidification unit should be fully supported to reduce the load and pressure caused by the gravity and operation of the pipeline.
- If the system is introduced into the dehumidification unit from outdoor fresh air, the air inlet should be sufficiently high from the ground to prevent the inhalation of dust and debris. The entrance must be far away from possible pollution sources, such as energy waste gas, steam and harmful gases.
- The dehumidification equipment can be installed in a room where dehumidification is required or in a separate room.
- In order to ensure the best dehumidification effect, the fan outlet should be equipped with a diffuser.

3.8 Negative-pressure Drainage Pipe Installation

- The installation of PVC drainage pipes requires 5mm insulation to prevent condensation.
- When the outlet of the drain pipe is an indoor unit with negative pressure, the drain pipe must use a water trap.

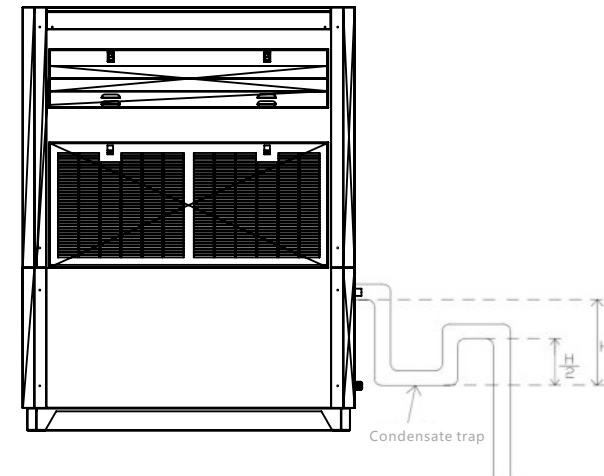

Correctly designed condensate trap (below)

Condensate system under normal operating conditions:

1. Level A reflects the negative static pressure.
2. Level C is at least 2 times the maximum negative static pressure.

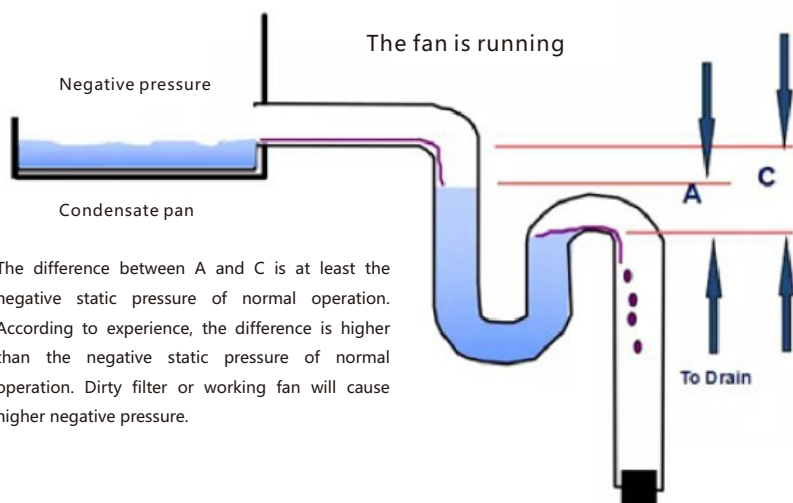

The difference between A and C is at least the negative static pressure of normal operation. According to experience, the difference is higher than the negative static pressure of normal operation. Dirty filter or working fan will cause higher negative pressure.

3.8.1 Drainage Pipe Test

- Please have a test after the installation of the drainage pipework.
- During the test, determine whether the water flow is passing through the pipeline correctly, and carefully observe the connection to ensure that there is no water leakage at the connection
- If the unit is installed in a house before renovation, it is recommended to test before ceiling renovation

3.9 Wiring

The electrical connection must be performed by qualified personnel in accordance with the electrical standards at the location of the equipment.

- The external control system must be compatible with the low-voltage control circuit of the dehumidification equipment.
- The detection element should be installed in a location that is not affected by dry or humid air and airflow outside the control area.
- The fusing power of the power supply fuse must be consistent with the power and type of the installed dehumidification equipment. The fuse should be installed
- Installed near the dehumidification equipment. The selection of the power supply cable and the main fuse should correspond to the correct operating power of the dehumidification unit.

- § Avoid placing the humidity probe near heat sinks or exposed to direct sunlight, because temperature changes will affect Actual detection value.
- The control circuit of the dehumidifier has been marked with different colors to prevent confusion. The unit design adopts single-phase AC power supply.
- § Before the unit is connected to the main power supply, check the single-phase AC power supply to ensure that the fluctuation range of the supplied voltage does not exceed the set point.
- Prepare $\pm 10\%$ of marked voltage and frequency. For high load occasions (due to the conversion of larger electrical equipment) can cause voltage Volatility, this check is particularly important.

3.10 Connection of external sensitive components (control parts)

Dehumidification equipment can be pre-arranged wiring to cooperate with the external control system, and provide wiring terminals for connecting external control components.

When installing the humidity detection element (sensitive element), its installation position should comply with the following requirements:

- Do not install the panel where the relative humidity cannot be accurately detected, such as near a window or near a water source
- The humidity detection element should be installed at a position 1 meter to 1.5 meters above the ground in order to detect representative water in the controlled area.
- Flat, or laid at the inspection point according to the design requirements.
- The unit must be grounded and a power isolation switch is provided to ensure that the equipment is cut off during inspection and service.
- The dehumidification unit cannot be operated at a voltage and frequency beyond the manufacturing range.
- The power supply of the dehumidification unit is equipped with a leakage protection device to make the unit safer.

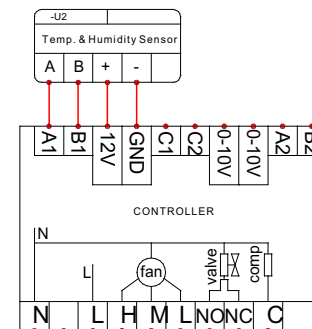
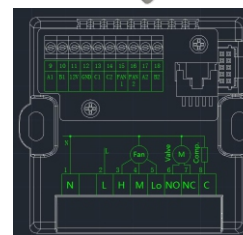

4. Ducting

4.1 Introduction

There are many ways to install dehumidifiers, including non-ducted installation, ducting for fresh Air, installation with HVAC system, etc.

Please read the manual carefully and consult relevant technicians and experts before installation.

4.1.1 Independent operation of dehumidifier

Put the dehumidifier in the room independently, so that the humidity in the room will drop quickly, without connecting the pipes.

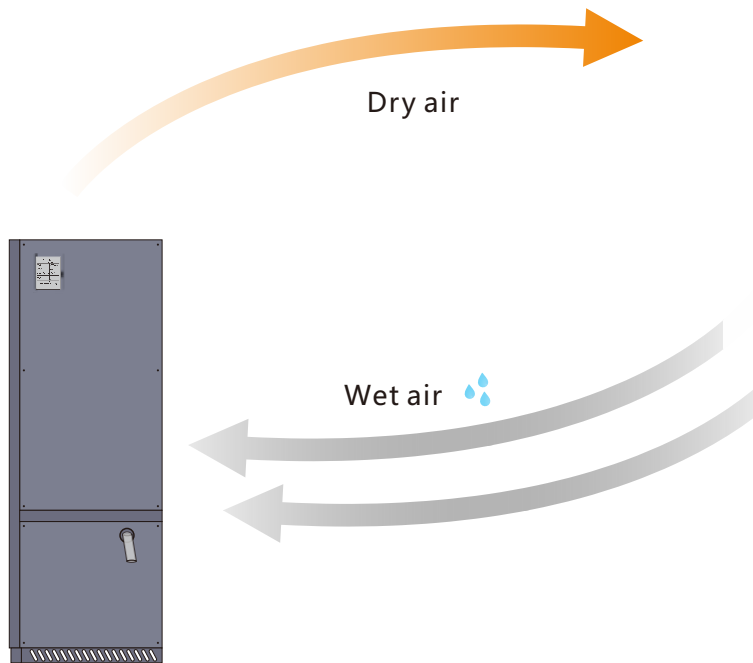

4.1.2 Ducting for Fresh Air

Do not draw air directly from the kitchen or washing machine room as fresh air. The dehumidifier can be placed outdoors to extract air as fresh air and then sent to a separate space after dehumidification, such as: paint spray room, purification room.

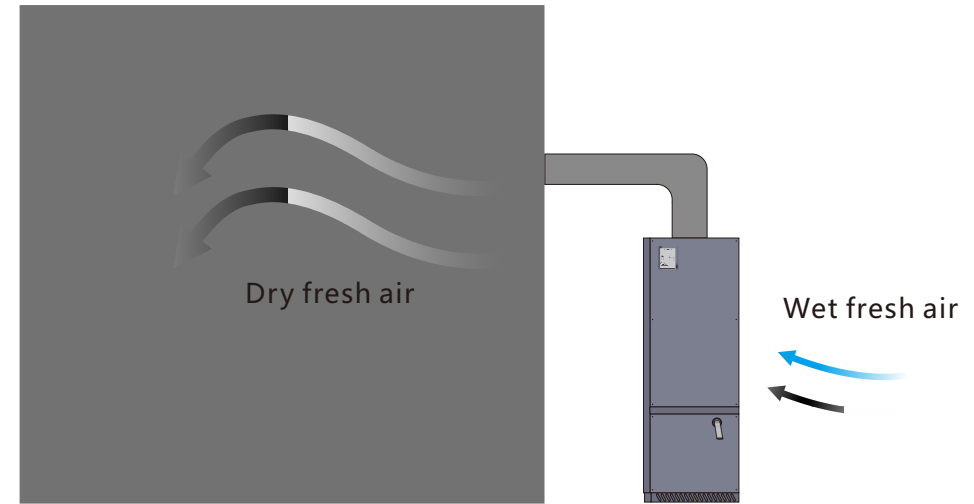

4.1.3 Installation with HVAC system

To dehumidify with HVAC system, place the dehumidifier outdoors, and connect the air outlet of the dehumidifier to the fresh air inlet of the AC unit to complete the matching. The humid outdoor air pass through the dehumidifier and then into the AC unit. The indoor return air of the AC unit is mixed with the dehumidified fresh air and sent into the room, which can reduce the humidity in the clean room and meet the process requirements in the workshop.

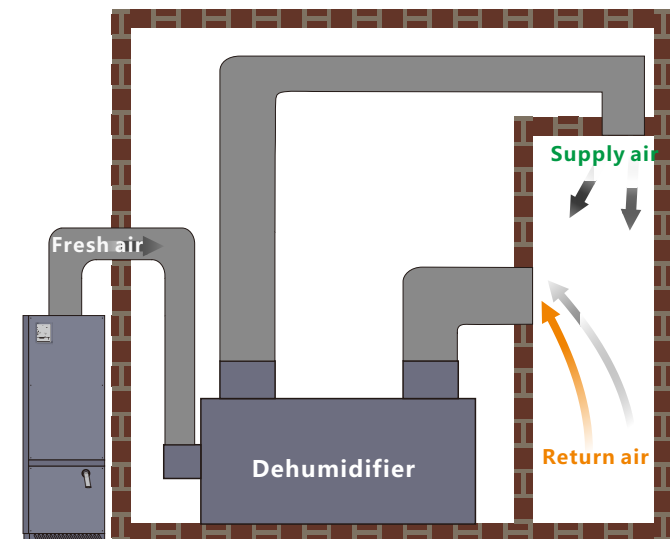

5. Commissioning

5.1 Introduction to Debugging

The control of the cabinet type dehumidification unit has been completed internally, and the indoor panel control can be carried out according to the process requirements. Before starting the equipment, please be sure to read the random technical manual and consult relevant technicians and experts to understand the operating parameters and setting parameters of the equipment to avoid incorrect operation.

5.2 Check before device startup

The commissioning and startup of the dehumidifier unit must be carried out by professional staff. Otherwise, the company will not be responsible for all the consequences caused.

- Make sure that the isolating switch is disconnected from the main circuit and the control on the panel is turned off at the same time
- Open the maintenance panel on the dehumidification equipment and make sure that there are no impurities in the equipment or electrical equipment box
- Check the installed air filter device to ensure it is in a clean state.
- Ensure that the main power fuse has an appropriate power rating. Check the built-in fuse.

5.2.1 Duct Check

- Check whether the equipment is installed in accordance with the designed location and space requirements
- The equipment requires fixed installation.
- Ensure that the air duct of the dehumidification system is connected according to the design requirements.
- Place all dampers in the half-open position.
- Ensure that the equipment transportation package and useless panels have been removed.
- Check whether other components on the device are installed correctly, and whether the resistance of electrical components is normal.

5.2.2 Wiring Check

- Ensure that the voltage and frequency of the power supply are consistent with the frequency of the power supply required by the device.
- Ensure that the supplied voltage meets the requirements of the equipment's electrical voltage, and the voltage fluctuation range does not exceed 10% of the marked voltage and frequency of each electrical equipment.
- The equipment should be grounded and an isolation switch should be installed to ensure that the equipment is insulated from the power supply during inspection and service.
- The power of the isolating switch and the fuse must be consistent with the model and type of the installed dehumidification unit.
- The power supply cable meets the design requirements.
- Check that all wire connections are secure.

5.2.3 Controller Check

- Check the installation location of external sensitive components (a representative location for humidity in the controlled area).
- Check whether the installation of control components and the connection of control wires are correct
- Ensure that the operating voltage of the control unit meets the requirements.
- After the control unit is powered, it is determined that there is no serious heating phenomenon.
- Check the configuration and setting parameters of the controller.

5.3 Unit Running

- Make sure that the dehumidification equipment is connected to the power supply. When the unit is in the standby state, turn on the button on the panel.
- Check whether the rotation direction of the fan is correct, the correct rotation direction should be consistent with the direction of the arrow marked on the fan casing
- Check whether the vibration of the dehumidifier is normal and whether there is noise inside the equipment.
- Press the panel shutdown button, the equipment should stop running and the unit returns to the standby state.
- Check whether the drainage is smooth and whether the drainage pipe is leaking.
- Whether there is a feeling of heat when touching the wires with your hands, please contact the manufacturer to ensure the specifications of the cables used.

5.4 Air rate Adjustment

- Start the dehumidification equipment to run continuously for 10 minutes.
- Adjust the valve on each air pipe to adjust the air flow according to the design and process requirements.
- After the air volume is adjusted correctly, lock the air valve in position.

5.5 Performance Test

- Ensure that the system air volume is rated or other required parameters, and check the equipment technical parameters to determine whether the dehumidification performance is normal.
- Repeat the check every 20 minutes to determine the stability of the dehumidification process.
- Detect the air moisture content of each return air branch and supply air of the air supply system, and calculate whether the mixing ratio is normal.
- Record the test results of each status point in the commissioning report.

Note: The testing instrument must be calibrated. Each test should be separated for a period of time to ensure accuracy.

6. Controller

6.1 General

6.1.1 Controller Terminals:

| Terminal | Description | Load |
|-------------|--|------------------------------------|
| L-N | 220VAC | Power supply |
| Relay 1--H | 220VAC output Max 1A | High fan speed |
| Relay 2--M | 220VAC output Max 1A | Medium fan speed Fan coil valve |
| Relay 3--L | 220VAC output Max 1A | Low fan speed;Humidifier |
| Relay 4--C | 220VAC output Max 1A | Compressor |
| Relay 5--NO | 220VAC output Max 1A SPDT(single-pole double-throw) | Air damper open |
| Relay 5--NC | 220VAC output Max 1A SPDT(single-pole double-throw) | Air damper close |
| EC FAN1 | 0--10V | EC motor supply fan |
| EC FAN2 | 0--10V | EC motor exhaust fan |
| GND | Weak current common terminal | |
| RS485--AI | Communicate with external temp.& humidity sensor | |
| RS485--BI | Communicate with external temp.& humidity sensor | |
| RS485--A2 | Communicate with third-party | |
| RS485--BI | Communicate with third-party | |
| 12VDC | Power the external temp.& humidity sensor | |

6.1.2 Terminals Diagram:

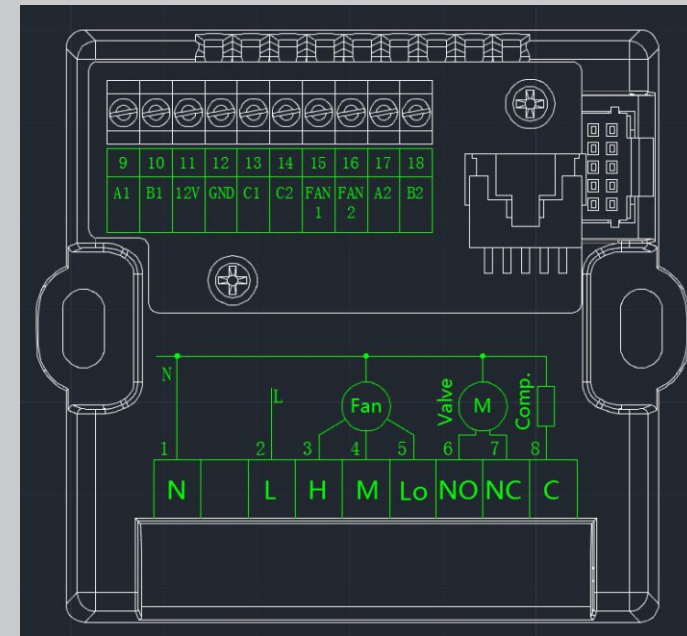
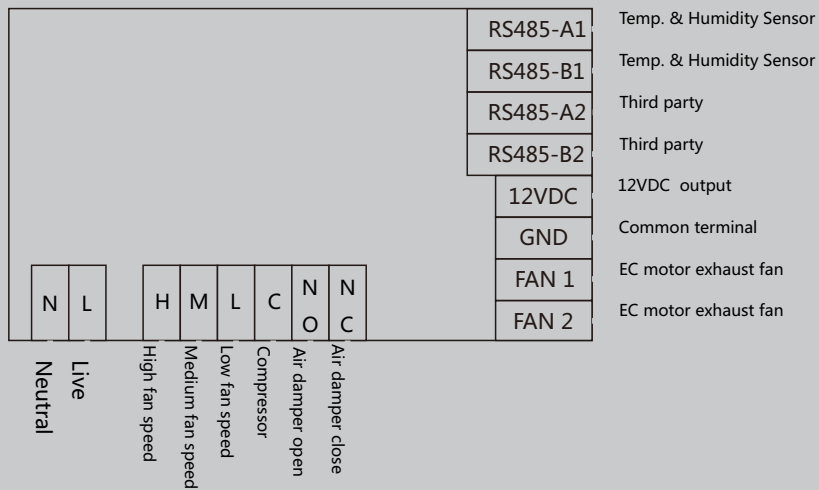

6.1.3 Controller' s Interface:

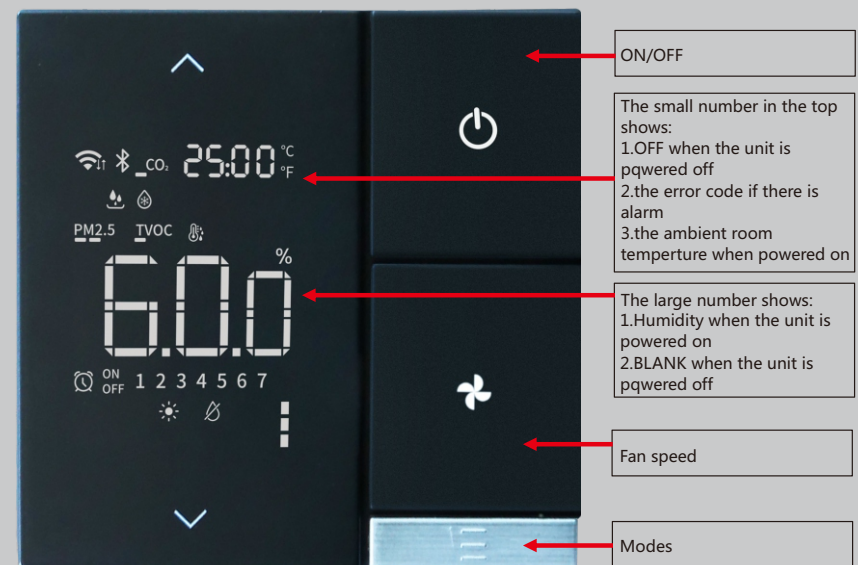

6.1.4 Parameters Setting

A.General parameters

ON/OFF:

Short press to turn on/off the controller:the small OFF appear in the top when the unit is powered off and disappear after 3 minutes

Short press to to exit during parameters setting.

Fan Speed

Press to adjust the fan speed.

Air Damper:

Press to open or close the air damper.

Mode Change:

Short press & simultaneously to change the available system working mode.

Humidity Set:

Press to reduce humidity, press to raise humidity (1% changed each press).

Only for the available system working mode.

Short press & simultaneously to change the available system working mode.The temperature in the top will flash,press to reduce temperature, press to raise temperature (0.5°C changed each press).

5 seconds without setting,the value will be saved and exit

Filter:

Long press Short press & simultaneously for 5 seconds to display the run time,wait for 5 seconds to exit;

Long press for 10 seconds to clear the alarm and reset the time.

B.Factory Parameters

Factory parameters setting:

Long press for 5 seconds to enter the factory parameters setting mode:the parameters code

R,P,O,H,C,A,D,F will appear;Press or to select the parameters code R,P,O,H,C,A,D,F;

Short press to set the available code;

Factory parameters setting:

Long press for 5 seconds to enter the factory parameters setting mode:the parameters code R,P,O,H,C,A,D,F will appear;

Press or to select the parameters code R,P,O,H,C,A,D,F;

Short press to set the available code;

Press or to adjust the code value;

Short press to save the code value;

Short press to exit without saving during the code value setting or return to the previous page;

Long press & & simultaneously for 3 seconds to reboot the controller's setting;

10 seconds without setting,the value will not be saved and exit to the home screen.

6.1.5 Icon:

| | | | | | |
|--|---|--|---|--|---|
| | WiFi connection established | | - Compressor working - Flashing when the minimum absolute humidity protection is activated | | 100% fresh air |
| | WiFi connection not established | | Humidification | | Dehumidification mode |
| | ESP32 trigger | | Timer | | 100% return air |
| | Defrost | | H05=1, temperature in degrees Fahrenheit | | Mixed fresh and return air |
| | Filter max. working time alarm, disappear after reset | | H05=0, temperature in degrees Celsius | | Current humidity |
| | Heating mode | | Cooling mode | | Current air speed, AC 3 speeds, EC 1~5 speed. |
| | Compressor relay output active | | | | |

6.2 Working Mode:

6.2.1 Dehumidification Working Mode

| | |
|-----------|------------------|
| Mode Code | H04=0 |
| Function | Dehumidification |
| Relay 1 | High fan speed |
| Relay 2 | Medium fan speed |
| Relay 3 | Low fan speed |
| Relay 4 | Compressor |
| Relay 5 | Air damper open |
| | |

6.2.2 Description

If the humidity of the air is higher than the setting, the fan turns on;5 seconds later,the compressor turns on;

If the humidity of the air is lower than the setting, the compressor turns off;3 minutes later,the fan turns off.

The compressor should cycle on and off at an interval more than 3 minutes.

6.3 Initial Value

The controller has data memory function when there is power failure.

The initial value as below:

- Fan speed:High
- Air damper:close
- Mode:the same before the power failure

6.4 Fan Control

- The initial value is high speed,can be adjusted manually.
- EC motor (0~10V) fan has 5 fan speeds,which can be set separately.
- AC motor fan speed can be adjusted manually when H04=0:
- F01=1,high fan speed available
- F01=2,high fan speed & low fan speed available
- F01=3,high fan speed & medium fan speed & low fan speed available
- High fan speed & low fan speed available when H04=1.
- High fan speed available when H04=2.
- Fan works according to F02 when achieve the set humidity and temperature (only for the available system working mode):
- F02=1,the fan turns off 3 minutes later after achieved the set humidity and temperature (only for the available system working mode)
- F02=2,the fan keeps working after achieved the set humidity and temperature (only for the available system working mode)

6.5 Air Damper Control

- Air damper works according to H01,R03 when the unit is turned on manually.
- Open or close air damper manually when H01=0:
- Air damper close:100% return air
- Air damper open:mixed fresh and return air
- Open or close air damper automatically when H01=1:
- Indoor humidity \geq R03:air damper close;Indoor humidity \leq R03~R04:air damper open.
- Can switch to manual mode from automatic mode and works manually for 30 minutes amd continue to work automatically.
- Air damper close when the unit is powered off manually.

6.6 Defrost Control

(1) Defrost conditions:

Indoor temperature \leq D3,Defrost interval \geq D1

(2) Defrost mode:

compressor cycle off & fan runs at high speed

(3) Defrost stop conditions:

- Defrost time \geq D2;
- Unit is turned off manually;
- Unit is turned off faulty.

6.7 Alarm

6.7.1 Filter Alarm

If the fan's running hour \geq H02,the filter alarm icon will appear.Reset the timer,the alarm will disappear.

6.7.2 Built-in temp.&humid sensor Error

When H03=1

if there is an open/short circuit of the humidity sensor or abnormal data(out of the normal temp.&humidity range),only the fan keeps working.

The error code is E01.It will resume operation after the error addressed.

6.7.3 RS485-1 Communication Error

When H03=0

if there is RS485-1 communication failure,only the fan keeps working.

The error code is E03.It will resume operation after the error addressed.

6.8 Working Status Display

| Type | Range | Precision |
|--------------------|--------------------------|-------------|
| Indoor temperature | -30.0~99.0°C , -22~210°F | 0.1°C , 1°F |
| Indoor humidity | 1~100% | 0.1% |
| Absolute humidity | 0.0~99.9 | 0.1g/kg |
| Fan's running time | 0~999 | 10 hours |

6.9 Error Code

| Error | Code |
|--|------|
| Built-in temp. & humidity sensor failure | E01 |
| External temp. & humidity sensor failure | E02 |
| RS485-1 communication failure | E03 |

6.10 External temp. & humidity sensor

RS485-1 Modbus communication protocol Address:13 Baud rate:9600 Parity:8N1

| Name | Add | Code | Byte | Read Only or Read/Write | Precision | Data Type |
|-------------|-------|------|------|-------------------------|-----------|-----------|
| humidity | 0000H | 03 | 2 | Read Only | 0.10% | Temp1 |
| temperature | 0001H | 03 | 2 | Read Only | 0.1°C | Temp1 |

6.11 Parameters Code Description

| Code | Parameters | Default | Precision | Range |
|------|---------------------------------------|---------------|---------------|--|
| R01 | Humidity set(dehumidify) | 50% | 1% | 1%-99% |
| R03 | Air damper automatic close/open value | 50% | 1% | 1%-99% |
| R04 | Air damper humidity differential | 3% | 1% | 1%-10% |
| R05 | Indoor temp. set | 25°C (77°F) | 0.5°C (1°F) | 5~35°C (41~95°F) |
| R06 | Humidity set (humidify) | 70% | 1% | 1%-99% |
| R07 | Humidity differential (humidify) | 3% | 1% | 1%-10% |
| H01 | Air damper automatic close/open | 1 | / | 0 - no in use |
| H02 | Filter alarm hour | 200 | 1 | 1 - in use |
| D01 | Defrost interval | 40 minutes | 1 minutes | 0 - no alarm 100-990, 1=10hours |
| D02 | Defrost stop | 10 minutes | 1 minutes | 30~60 minutes |
| D03 | Defrost start | 17°C (62°F) | 1°C (2°F) | 1~20°C (34~68°F) |
| F01 | AC fan speed set | 1 | / | 1 - low speed 2 - medium speed(DC motor fan:1,2 - low;3,4,5 - high) 3 - high speed(DC motor fan:1,2 - low;3,4 - medium;5 - high) |
| F02 | Fan set under achieved humidity | 1 | / | 1 - turns off 3 minutes later after achieved the set humidity 2 - keeps working after achieved the set humidity |
| F03 | FAN1, DC fan motor speed 1 voltage | 500 (5V) | 10 (0.1V) | 400~950 |
| F04 | FAN1, DC fan motor speed 2 voltage | 600 (6V) | 10 (0.1V) | F03~950 |
| F05 | FAN1, DC fan motor speed 3 voltage | 700 (7V) | 10 (0.1V) | F04~950 |
| F06 | FAN1, DC fan motor speed 4 voltage | 800 (8V) | 10 (0.1V) | F05~950 |
| F07 | FAN1, DC fan motor speed 5 voltage | 900 (9V) | 10 (0.1V) | F06~950 |
| F08 | FAN2, DC fan motor speed 1 voltage | 400 (4V) | 10 (0.1V) | 400~950 |
| F09 | FAN2, DC fan motor speed 2 voltage | 500 (5V) | 10 (0.1V) | F08~950 |
| F10 | FAN2, DC fan motor speed 3 voltage | 600 (6V) | 10 (0.1V) | F09~950 |
| F11 | FAN2, DC fan motor speed 4 voltage | 700 (7V) | 10 (0.1V) | F10~950 |
| F12 | FAN2, DC fan motor speed 5 voltage | 800 (8V) | 10 (0.1V) | F11~950 |
| P01 | RS485-2 Baud rate | 0 | | 0-4800 |
| P02 | RS485-2 Address | 1 | | 1-9600 |
| P03 | RS485-2 Protocol | 0 | | 1~255 |
| O07 | RS485-2 Communication status | | | 0-General open protocol |
| O09 | Software version | | | 0 - abnormal / 1 - normal |
| O10 | Dew point | | | |
| O11 | Absolute humidity | | | |

6.12 RS485-2 Modbus communication protocol

Function code description:

function 03 – read function 06 – write single function 16 – write multiple

| Address | Function Code | Object | Byte | Read Only or Read/Write | Data |
|---------|---------------|-----------------------------------|---------|-------------------------|--|
| 0x1001 | 03/03/16 | ON/OFF | 2 bytes | Read/Write | 0 - OFF 1 - ON |
| 0x1002 | 03/03/16 | fan speed | 2 bytes | Read/Write | 1 - 1st fan speed 2 - 2nd fan speed 3 - 3rd fan speed 4 - 4th fan speed 5 - 5th fan speed |
| 0x1003 | 03/03/16 | air damper close/open | 2 bytes | Read/Write | 0 - close 1 - open |
| 0x1004 | 03/03/16 | humidity set | 2 bytes | Read/Write | 1~99% |
| 0x1006 | 03/03/16 | air damper automatic humidity set | 2 bytes | Read/Write | 1~99% |
| 0x1008 | 03/03/16 | air damper automatic close/open | 2 bytes | Read/Write | 0 - not in use 1 - in use |
| 0x101B | 03/03/16 | temperature set | 2 bytes | Read/Write | 5~35°C |
| 0x101C | 03/03/16 | working modes | 2 bytes | Read/Write | 0 - dehumidification 1 - cooling+dehumidification 2 - heating+dehumidification 3 - cooling+humidification 4 - heating+humidification 5 - humidification |
| 0x101D | 03/03/16 | humidification set | 2 bytes | Read/Write | 1~99% |
| 0x2001 | 03 | indoor temperature sensor | 2 bytes | Read Only | |
| 0x2002 | 03 | indoor humidity sensor | 2 bytes | Read Only | |
| 0x2003 | 03 | external temperature sensor | 2 bytes | Read Only | |
| 0x2004 | 03 | external humidity sensor | 2 bytes | Read Only | |
| 0x2005 | 03 | fan running time | 2 bytes | Read Only | 1=10 hours |
| 0x2006 | 03 | failure | 2 bytes | Read Only | bit0:built sensor failure bit1:external sensor failure bit2:filter alarm bit3:minimum absolute humidity protection bit4:in defrost |
| 0x2007 | 03 | dew point | 2 bytes | Read Only | |
| 0x2008 | 03 | absolute humidity | 2 bytes | Read Only | |

6.13. Device connect Wi-Fi process

1. Connect smart phone to local router' s WIFI.
2. Open smart phone Bluetooth.
3. Download APP "smart life"



Scan QR code to download Smartlife App.

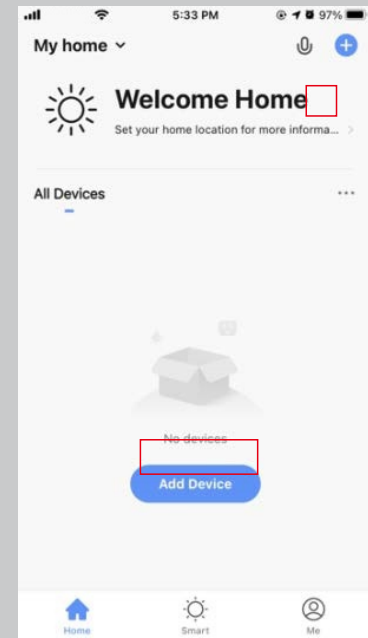

4. Open APP, and select "Add device"

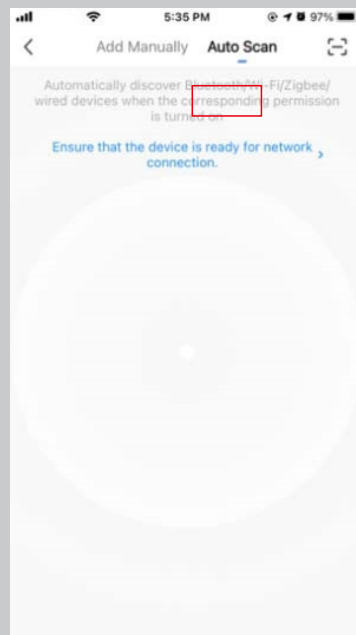

5. Slide to "Auto Scan"

6. Press and hold "on/off" button for 10 seconds, until LCD full display. Then release the button.

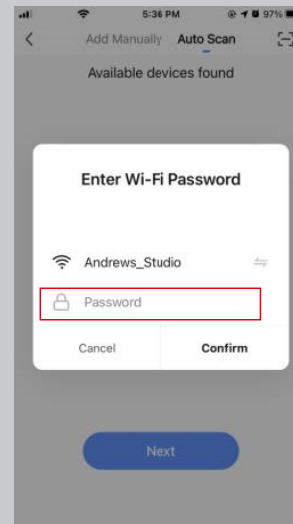

8. Enter WIFI password which your smart phone has connected and confirm.

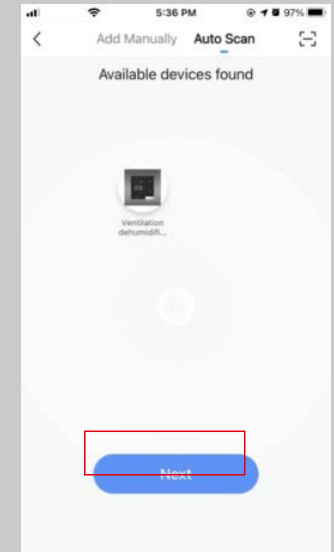

7. APP will discover the device automatically and click Next.

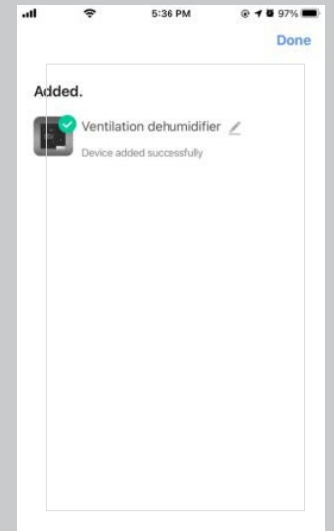

9. All set. Enjoy your smart device.

7. Maintenance

7.1 Introduction

The precision dehumidifier can run for a long time and only needs very little maintenance. The maintenance of the dehumidifier is beneficial to the long-term and good operation of the unit. The frequency of maintenance depends on the operating conditions of the dehumidifier and the quality of the installation environment. The maintenance cycle of dehumidification equipment should be determined according to the environment and installation location of the equipment. Therefore, the recommended maintenance period can be determined according to the actual situation. Improper maintenance may reduce the dehumidification performance.

7.2 Filter

The dehumidification equipment is equipped with an independent filter device to treat the return air. The filter device is installed at the return air of the equipment, so that the air that is about to enter the dehumidification equipment can be cleanly filtered. The interval between cleaning or replacing the filter device should be determined according to the amount of dust and particles in the air at the installation site. It is forbidden to operate dehumidification equipment without a filter device. Because in this case, dust and impurities may reduce the dehumidification performance of the equipment, and at the same time may cause the compressor to start frequently. It is recommended to inspect the filter unit at least once a month.

7.3 Motor

The motor is equipped with bearings. The service life of the bearing is the same as that of the motor, so no additional maintenance is required.

The motor is inspected once a year to ensure that its condition is normal.

7.4 Technical Description

The table lists service schedule of the general components. If necessary, please contact the manufacturer for more details.

| Name | Service Schedule | |
|-----------------|--|---|
| | 3~6 months | 12 months |
| Filter | Clean or replace | |
| Compressor | Check whether it is working normally and whether the vibration is normal | Check the wiring and make sure the wiring is not loose, check for damage and overheating. |
| Coil | Remove the dust and debris | |
| Defrost valve | | Check for overheating or blockage, check whether the circuit is normal |
| Seal | Check for signs of damage and displacement. If it is worn or damaged, it should be replaced. | |
| Humidity sensor | | Check whether it is working normally and calibrate correctly |

8. Troubleshooting

8.1 Troubleshooting Introduction

The purpose of this chapter is to help the operator of the unit to analyze the cause of the failure and master the method of troubleshooting. The control method of the precision dehumidification equipment can be easily connected with automatic control according to the requirements of use. In order to facilitate failure analysis, please refer to the circuit diagram and related materials provided with the random group.

- ⚠ There is a high voltage inside the dehumidification equipment. Before taking any troubleshooting measures, make sure that the power supply of the dehumidification unit is cut off.
- ⚠ There is a high temperature area (compressor) inside the dehumidification equipment, and the unit should be cooled down before maintenance work is carried out.
- ⚠ The adjustment, maintenance and repair of the unit should be carried out by qualified technicians, and the relevant personnel should be clearly aware of the high temperature and high pressure inside the dehumidification unit.

8.2 Troubleshooting procedures

The purpose of this chapter is to help the operator of the unit to analyze the cause of the failure and master the method of troubleshooting. The control method of the precision dehumidification equipment can be easily connected to the automatic control according to the requirements of use. In order to facilitate failure analysis, please refer to the circuit diagram and related materials provided with the random group.

| Problem | Reason | Troubleshooting |
|-----------------------------|---|---|
| Poor dehumidification | - Filter blocked - Reduced air flow - Air leak | - Clean or replace the filter - Check the supply air outlet and adjust the air rate - Check the panel and seal |
| Circuit breaker tripped off | - Fan failure | - Check the fan and motor |
| Unit does not work | - No power to controller - Controller failure - Phase short circuit - Circuit breaker failure - Unit unplugged or no power to outlet. | - Check controller fuse - Check external on/off signal - Check main circuit breaker and phase - Check electrical parts - Power the unit |
| No dehumidification | - Frost on the evaporator - Air damper not fully opened - Filter blocked - Humidity set too high | - Check the pipe - Open the air damper - Replace the filter - Set lower humidity |
| No dry air | - Filter blocked - Fan failure - Phase failure - Supply air duct blocked | - Replace the filter - Check the fan and motor - Check main circuit breaker and phase - Check the air duct |

9. Electric Diagram

The circuit of the dehumidification unit has been completed internally and can be modified and controlled according to process requirements. Before modifying the circuit of the equipment, please be sure to read the random technical manual and consult relevant technicians and experts to understand the operating parameters and setting parameters of the equipment to avoid incorrect operation.

